







INSTRUCTION SHEET

SH-BRK

QUICK-POSITION™ SHELF

FEATURES: Quick-Position™ Shelf (SH-BRK) mounts without rack screws and accepts rear mounting of power (PD-815SC or PD-815SC-NS).

Hardware Included (per shelf):

Qty		Description
4		Pins
2		Wood Screws
4		Nuts
4		Studs
2		Rear Brackets
1		Wrench

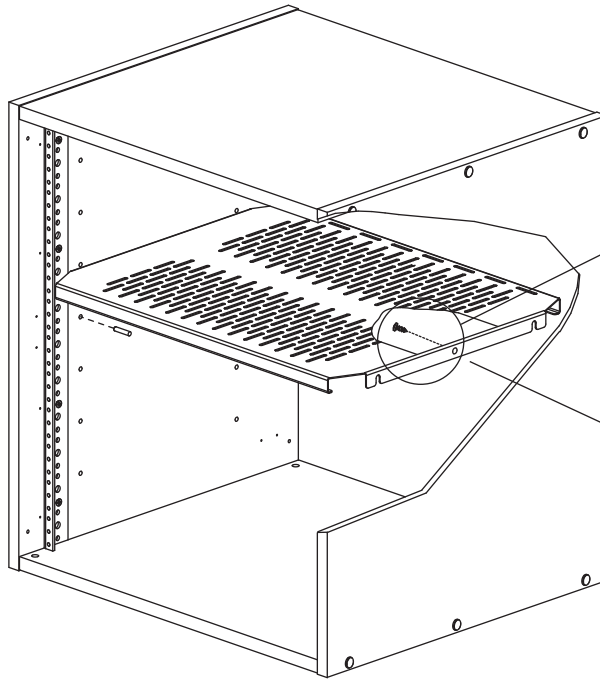

For added stability, use center hole in shelf side to secure with provided wood screws.

- 1) Select location for shelf.
- 2) Install 4 pins (Insert fully).
- 3) Install shelf.
- 4) Install wood screws where shown if added stability is desired.
- 5) Using the wrench provided, install rear brackets to prevent component from sliding back (Rear Brackets can be mounted 4 different ways).

FRONT

REAR BRACKETS

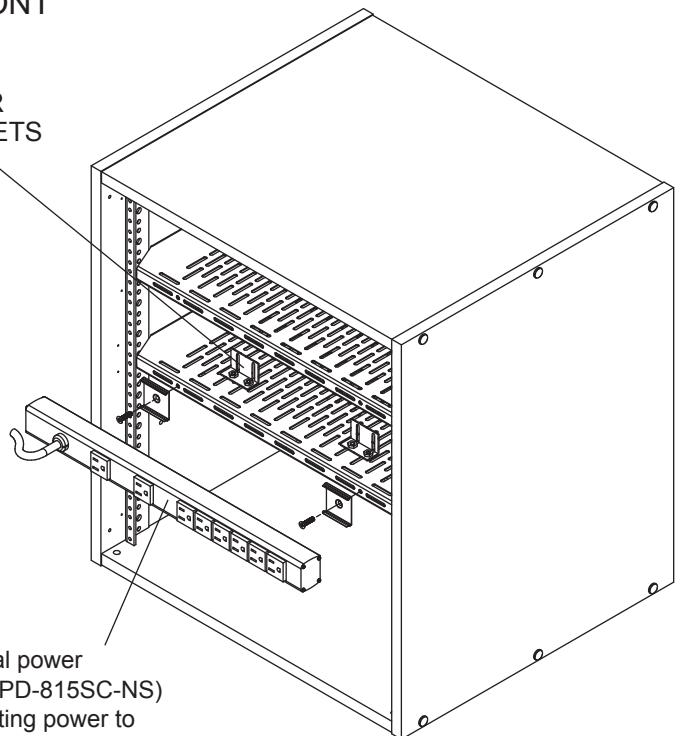

Use rear of shelf to manage cables and mount power strip (Do not mount circuit breaker reset button flush against side of rack)

Optional power (PD-815SC or PD-815SC-NS)

When mounting power to shelf, optional rear rackrail must be in setback position

REAR

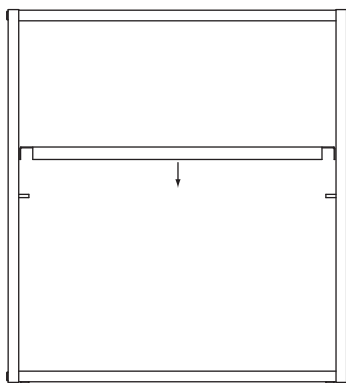

NOTE: Shelves can be used with or without rackrail installed

WARRANTY

Middle Atlantic Products, Inc. (the "Company") warrants the SH-BRK to be free from defects in material or workmanship under normal use and conditions for a period of (7) seven years from date of shipment by the Company.

The Company's entire liability to the purchaser, and the purchaser's (or any other parties) sole and exclusive remedy, under this warranty shall be limited, at the Company's option, to either (a) return of and refund of the price paid for, or (b) repair or replacement at the Company's factory of the products purchased, or any part or parts thereof, which the Company has determined to be defective after inspection thereof at the Company's factory.

This warranty does not cover damage due to acts of God, accident, misuse, abuse or negligence by parties other than the Company, or any modification or alteration of the products. In addition, this warranty does not cover damage due to improper handling, assembly, installation or maintenance.

THIS WARRANTY IS IN LIEU OF ALL OTHER WARRANTIES OF ANY KIND, EITHER EXPRESSED OR IMPLIED, INCLUDING, BUT NOT LIMITED TO, IMPLIED WARRANTIES OF MERCHANTABILITY AND FITNESS FOR A PARTICULAR PURPOSE.

TO THE MAXIMUM EXTENT PERMITTED BY APPLICABLE LAW, IN NO EVENT SHALL THE COMPANY BE LIABLE FOR ANY SPECIAL, INCIDENTAL, INDIRECT, OR CONSEQUENTIAL DAMAGES WHATSOEVER (INCLUDING, WITHOUT LIMITATION, DAMAGES FOR LOSS OF BUSINESS PROFITS, BUSINESS INTERRUPTION OR ANY OTHER PECUNIARY LOSS) ARISING OUT OF THE USE OF THE PRODUCTS PURCHASED, EVEN IF THE COMPANY HAS BEEN ADVISED OF THE POSSIBILITY OF SUCH DAMAGES. THE COMPANY'S LIABILITY TO THE PURCHASER (OR ANY OTHER PARTY) HEREUNDER, IF ANY, SHALL IN NO EVENT EXCEED THE PURCHASE PRICE OF THE PRODUCTS PAID TO THE COMPANY.

Corporate Headquarters

Corporate Voice 973-839-1011 - Fax 973-839-1976
International Voice +1 973-839-8821 - Fax +1 973-839-4982
middleatlantic.com - info@middleatlantic.com

Middle Atlantic Canada

Voice 613-836-2501 - Fax 613-836-2690
middleatlantic.ca - customerservicecanada@middleatlantic.ca

Factory Distribution

USA: NJ - CA - IL Canada: ON - BC

At Middle Atlantic Products we are always listening. Your comments are welcome.

Middle Atlantic Products is an ISO 9001 Registered Company.

